

AURALiC

G Series World Premiere 2017 High End Munich

New iPad Lightning DS

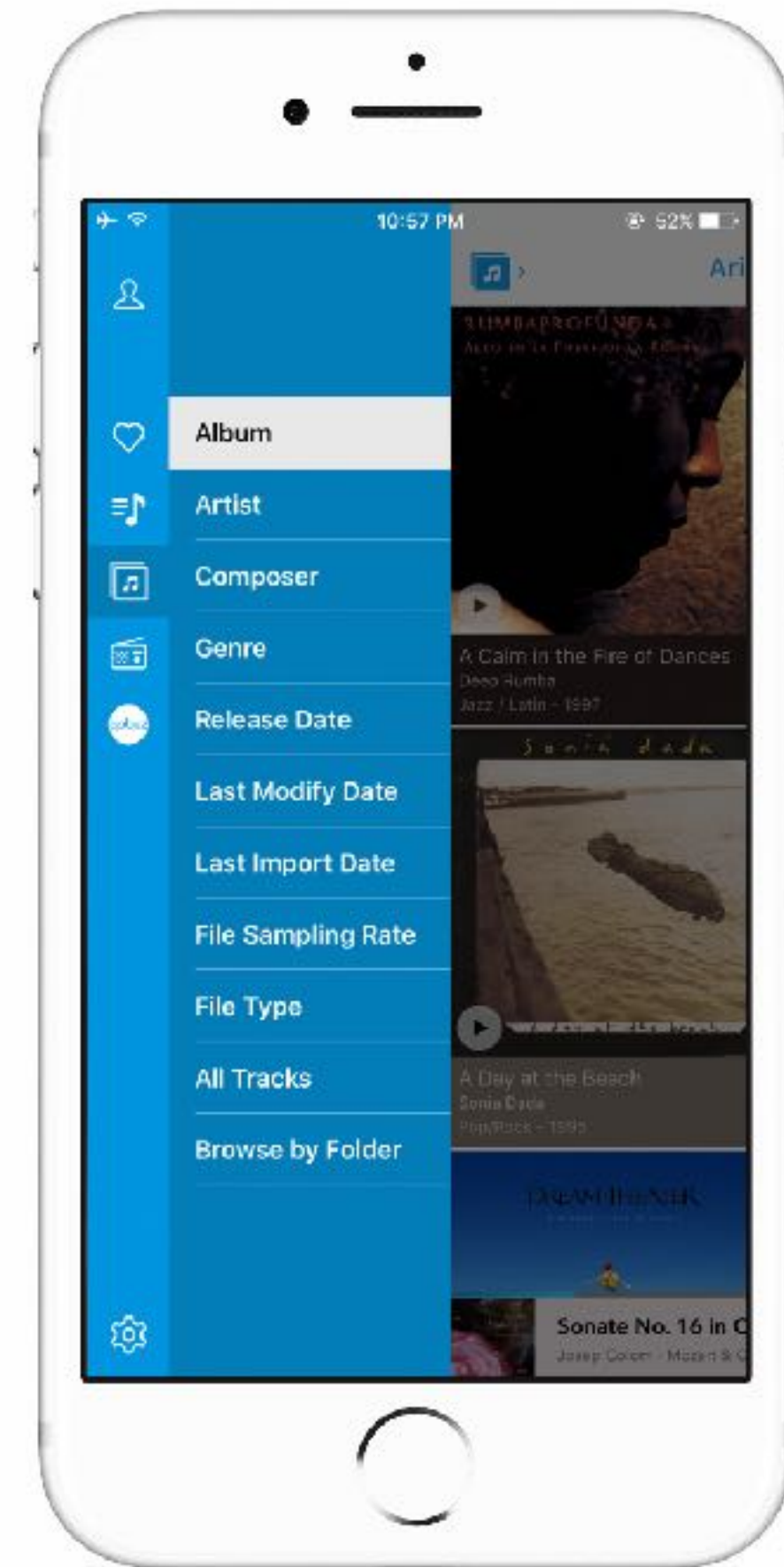
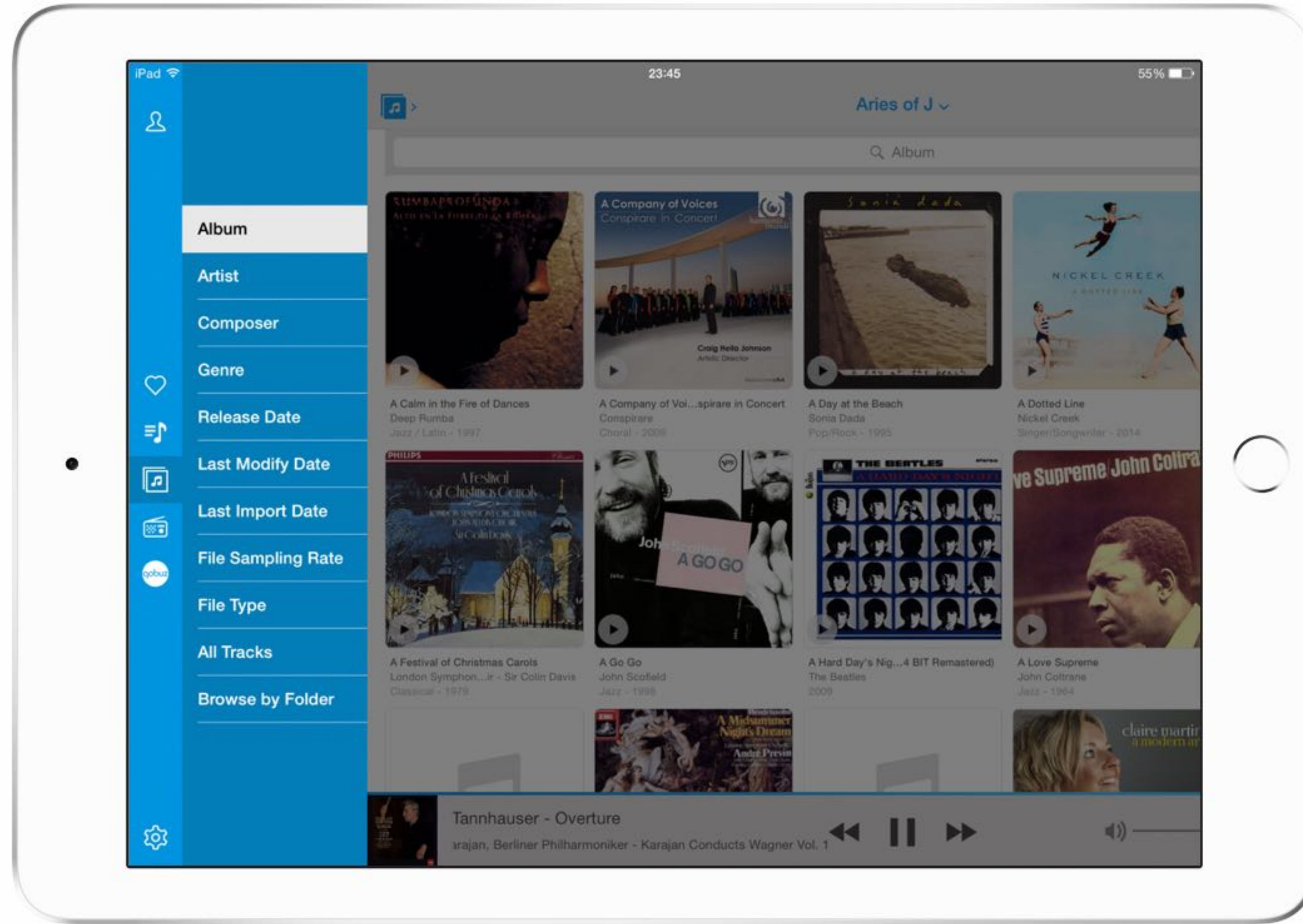

iOS Lock Screen Control

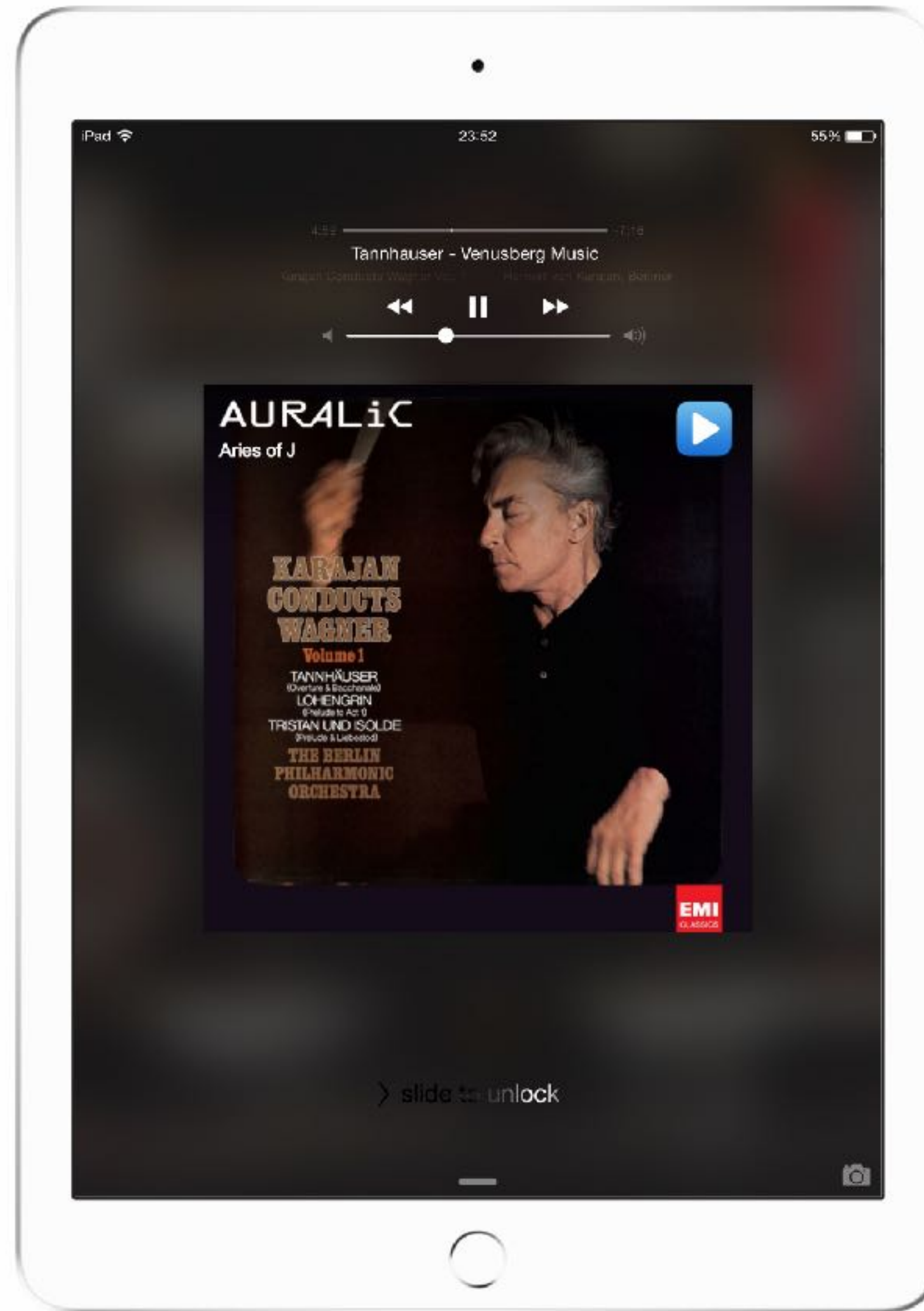

Memory Cache

“What's striking is that compared to last time (Aries w/ 3.3 firmware), Aries delivered more micro details AND more smoothness at the same time. The sound did not come across as being smeared, in fact quite the opposite. Realism was stepped up another notch and we did not get the impression of the sound being overly dynamic, just more engaging and pleasurable to listen to. We believe the improvements are largely attributed to the memory-based playback. Having owned the Aries Femto for well over a year, it was quite shocking to hear extent of SQ improvement with just a firmware update. We have to give the folks at Auralic a big nod, for their amazing combination of great engineering and excellent ears.”

From “scan80269” on Computeraudiophile Community

Browser Control Interface

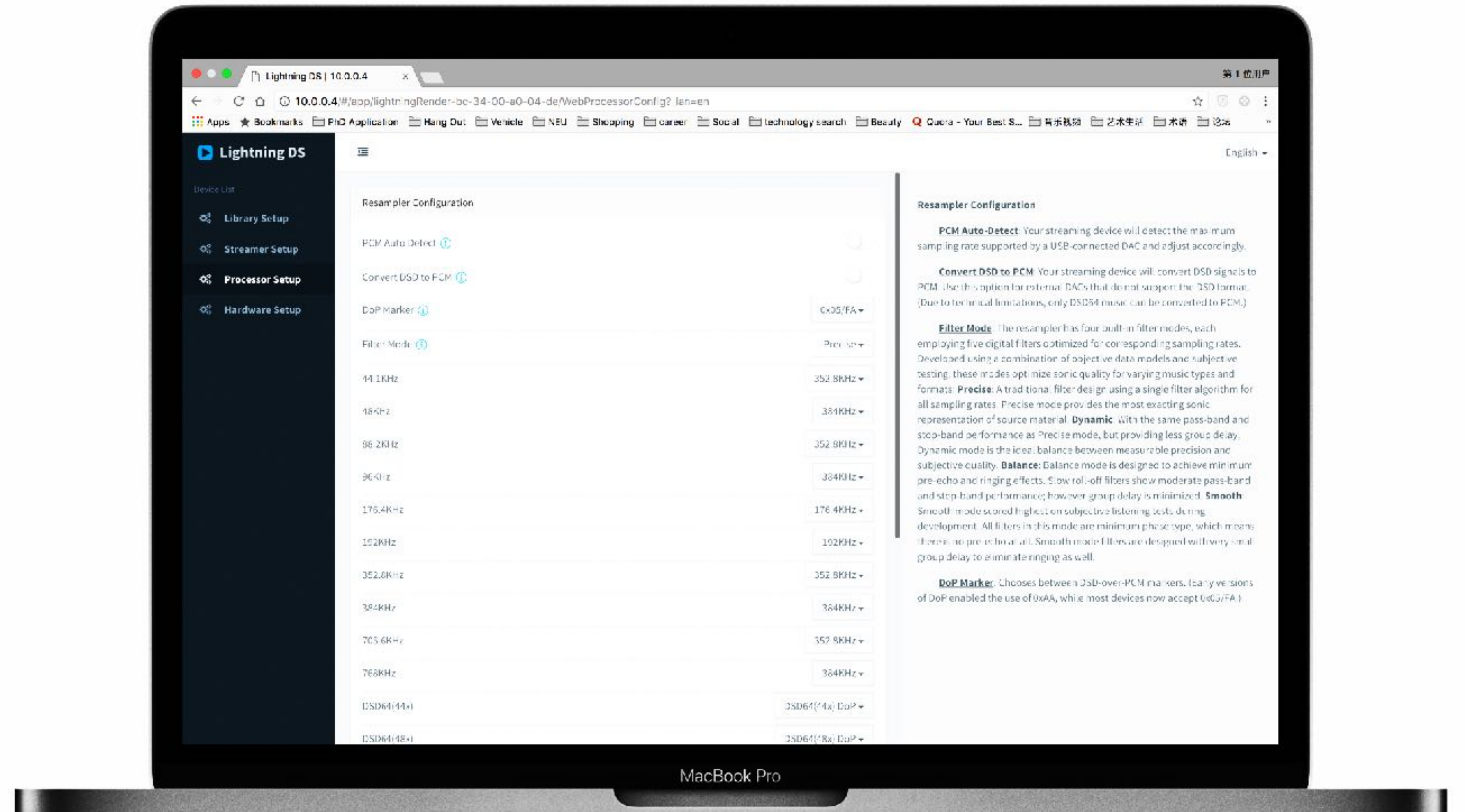
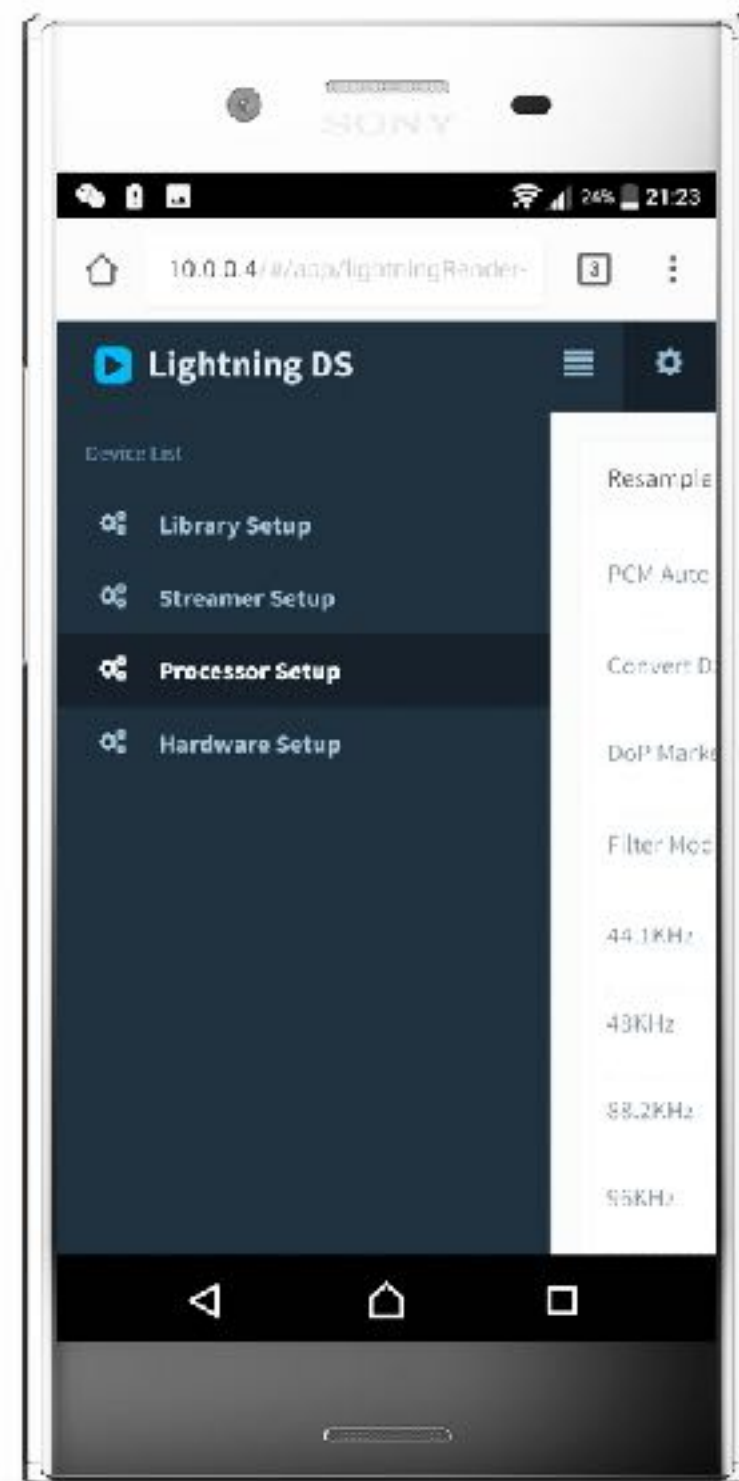

Processing Engine

- Allows complex signal processing
- Resampler
- Other functions to come
- Setup through browser interface

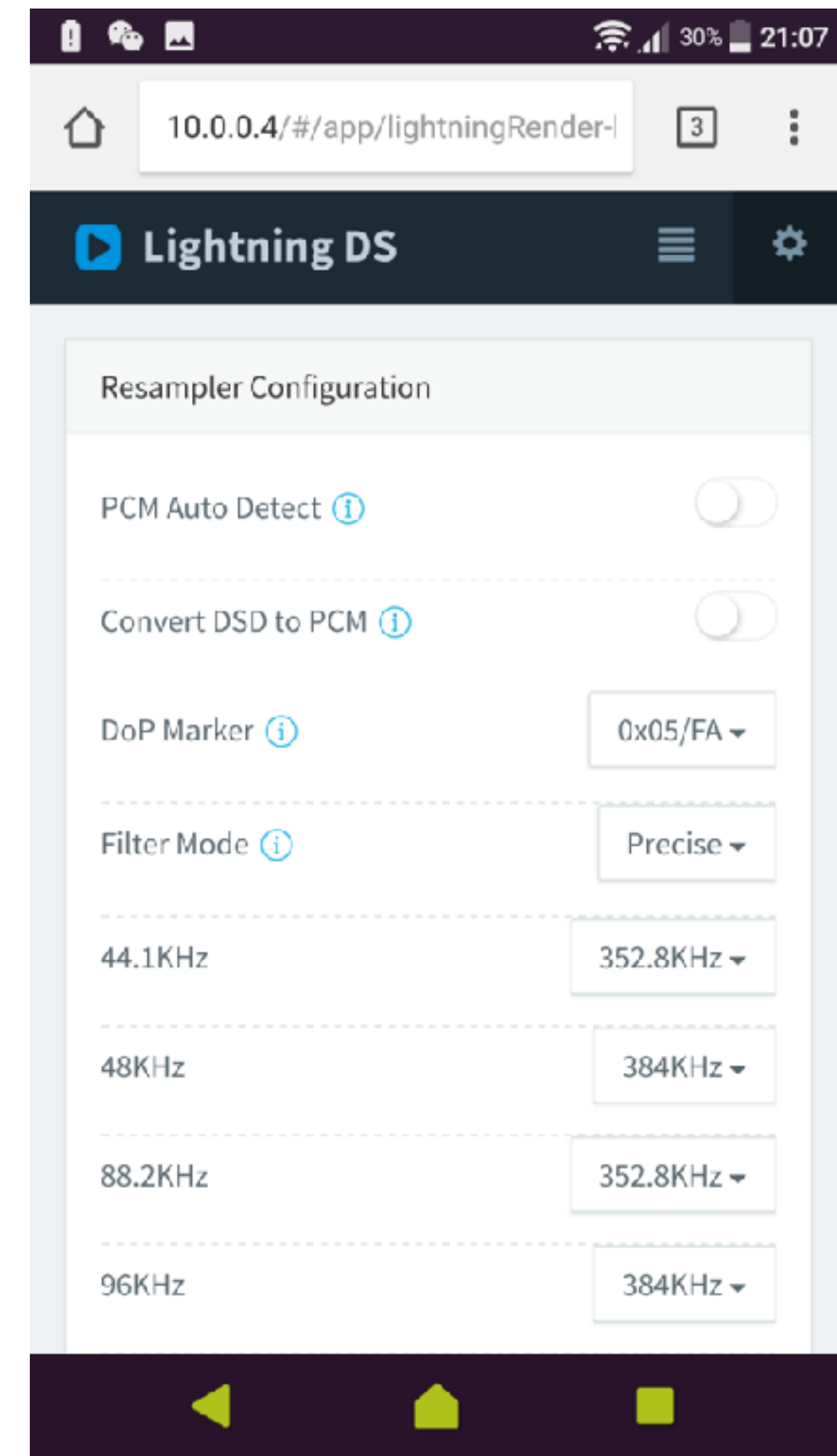

New Products in 2016

***ALTAIR** Streaming DAC*

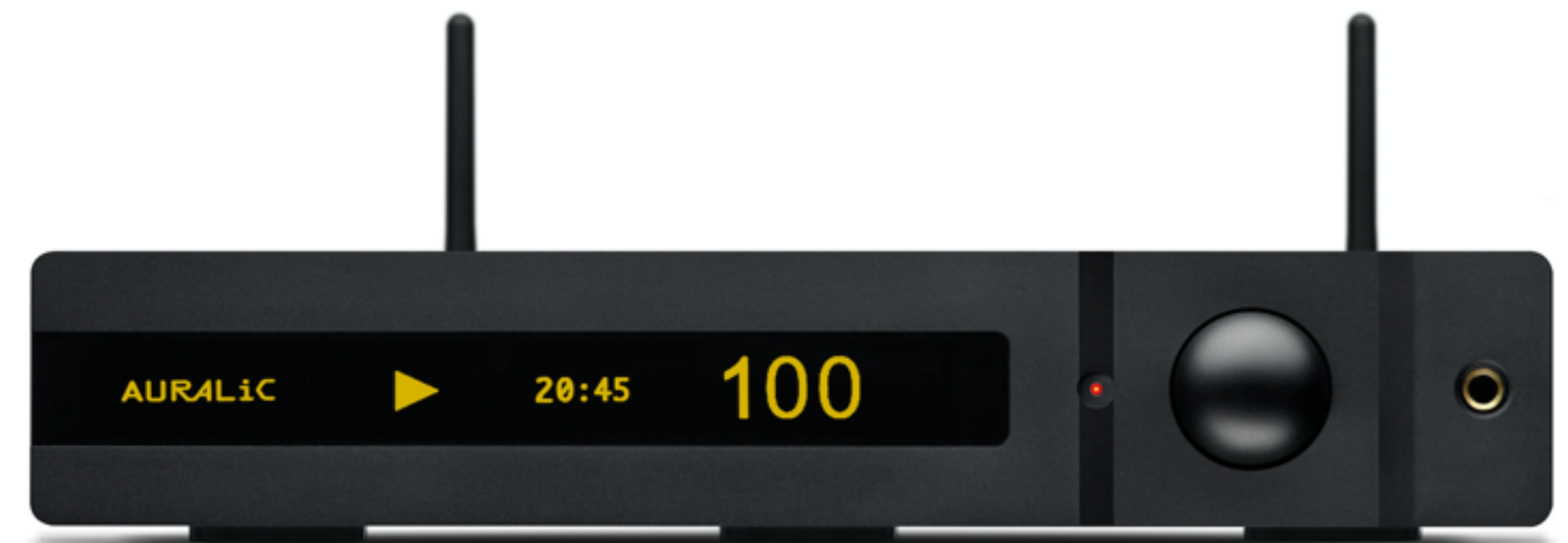

***POLARIS** Streaming Amplifier*



Where is AURALiC going?

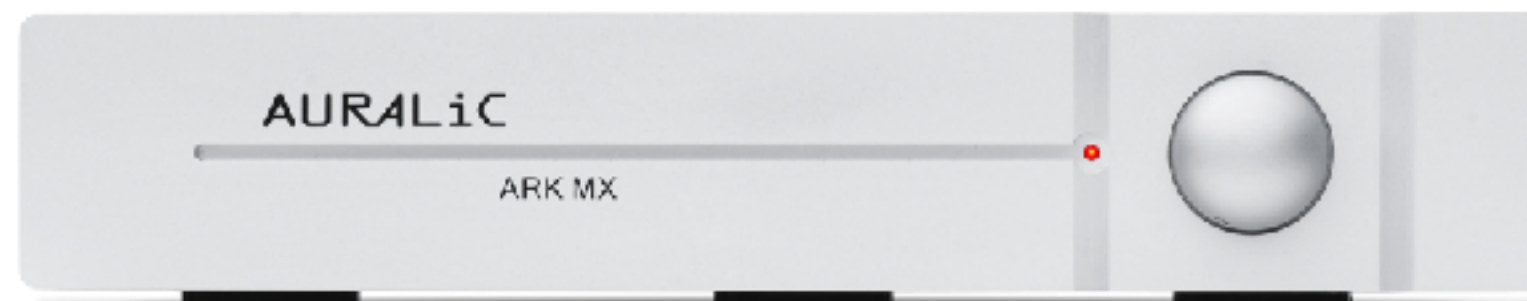
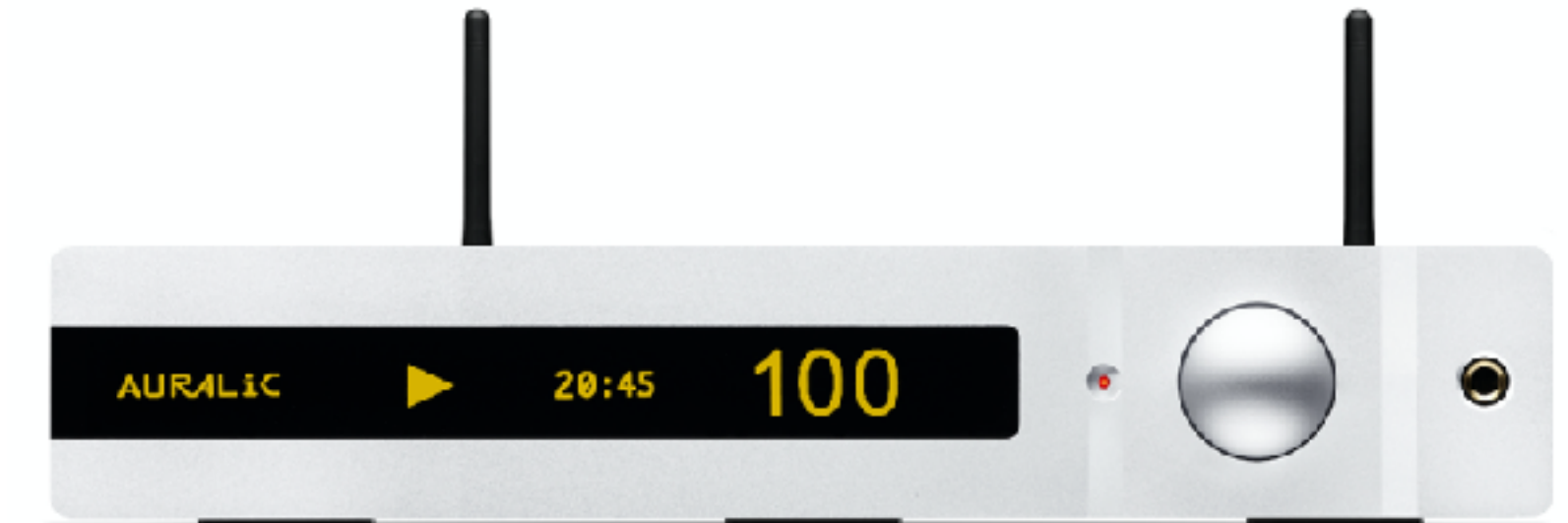
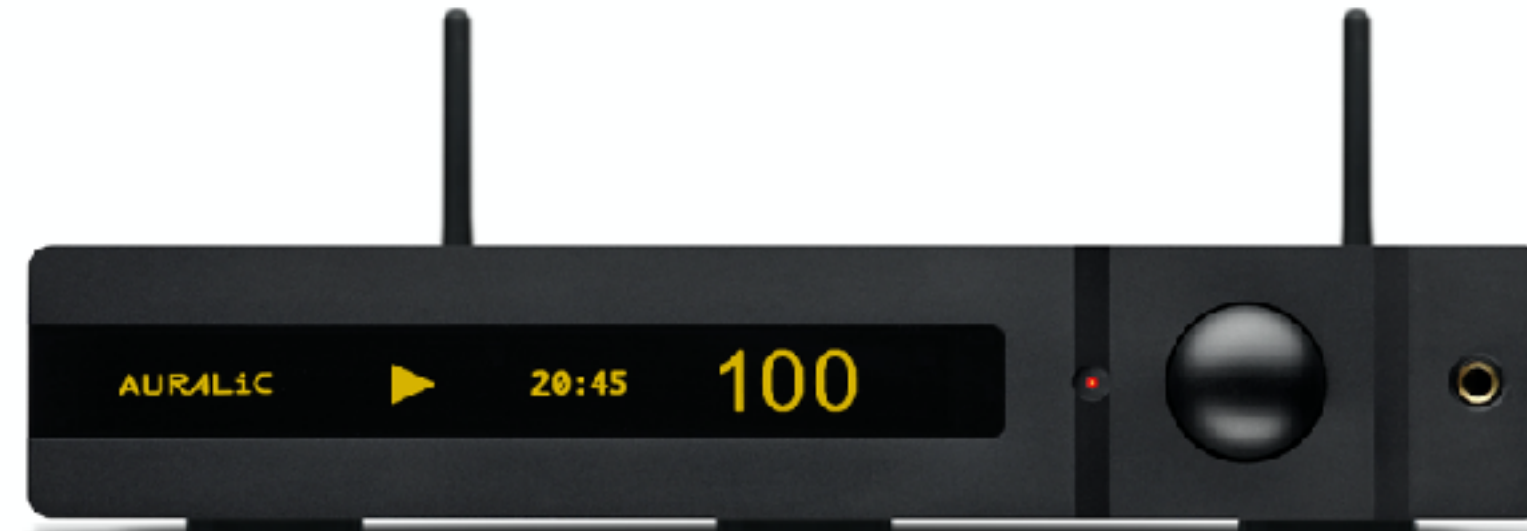
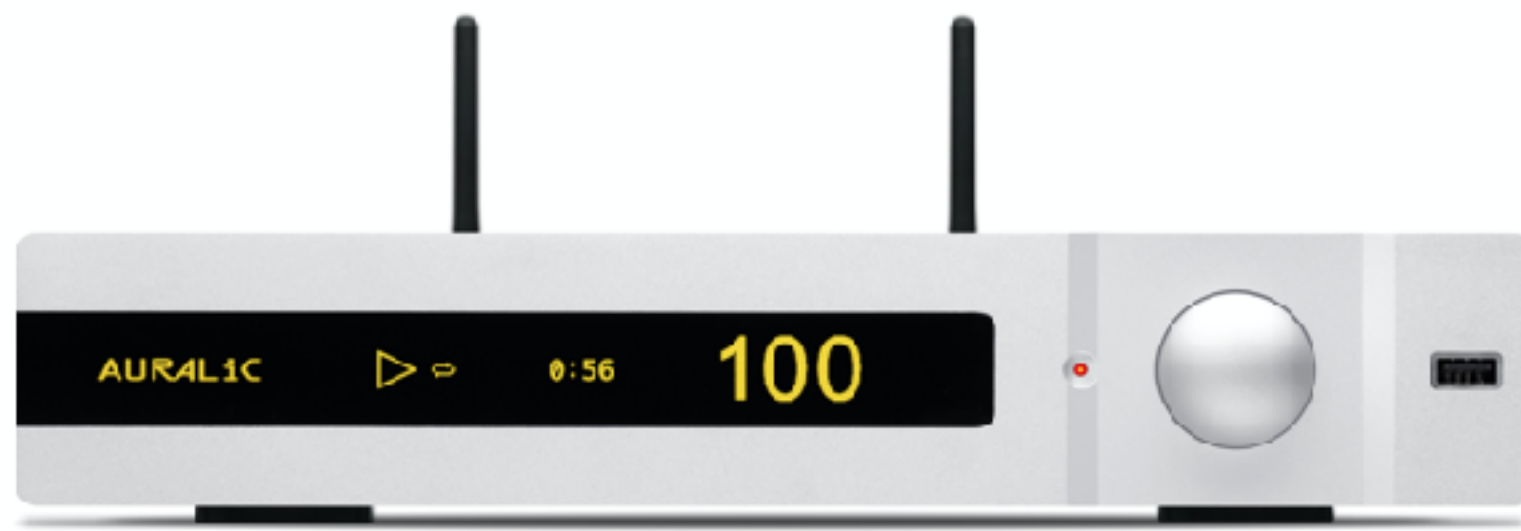

Industrial Design Evolution

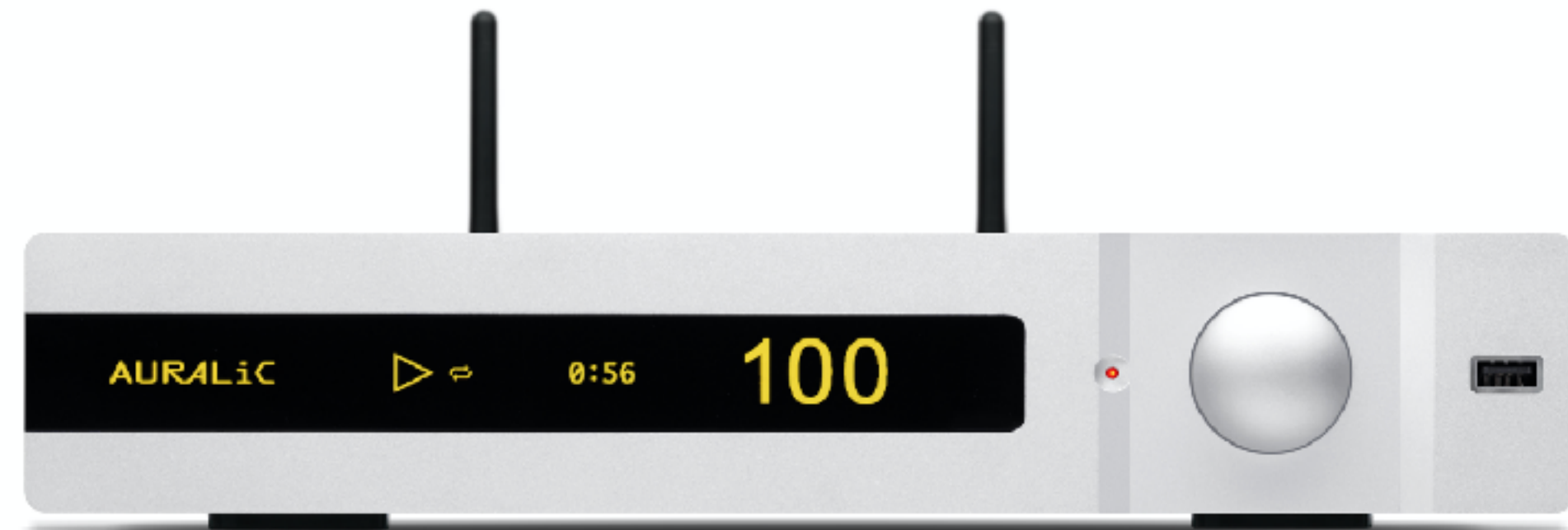

Technology Breakthrough

2012: VEGA

First DSD128 capable DAC
In the Industry



2014: ARIES

First Wireless Streaming Bridge
In the Industry



Design Focus

Ultra High-Res: DSD256/DSD512

Low-Res: Online streaming

Design Concept

Industrial Design - Evolution

Technology - Breakthrough

Ultra High-Res - Bring full potential

Low-Res - Subjective optimization

Hello, G Series



ARIES G2 Streaming Transporter



LEO G2 Reference Master Clock



SIRIUS G2 Upsampling Processor



VEGA G2 Streaming DAC

Definition of "G"

G: Grade, multi-grades in the future

G2: Highest positioning of the line, period.

Fusion of the existing product line

Design Evolution - Unity Chassis



Meet ARIES G2



Meet ARIES G2

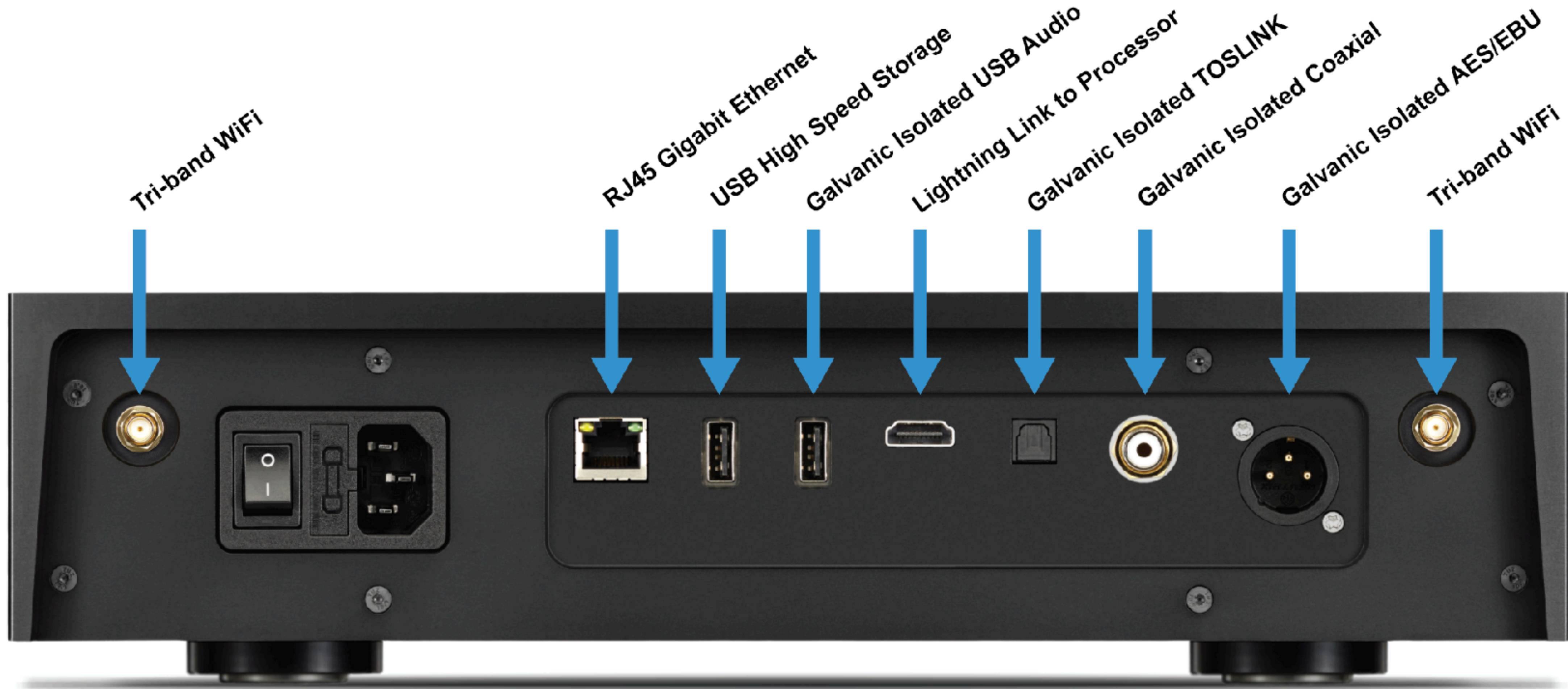

Introducing Lightning Link

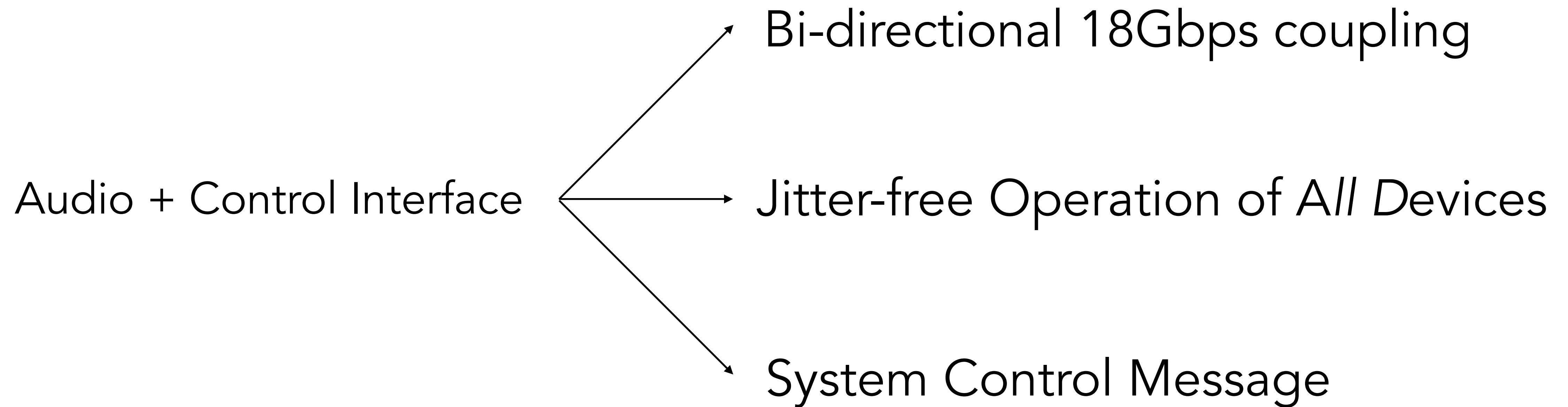

Lightning Link

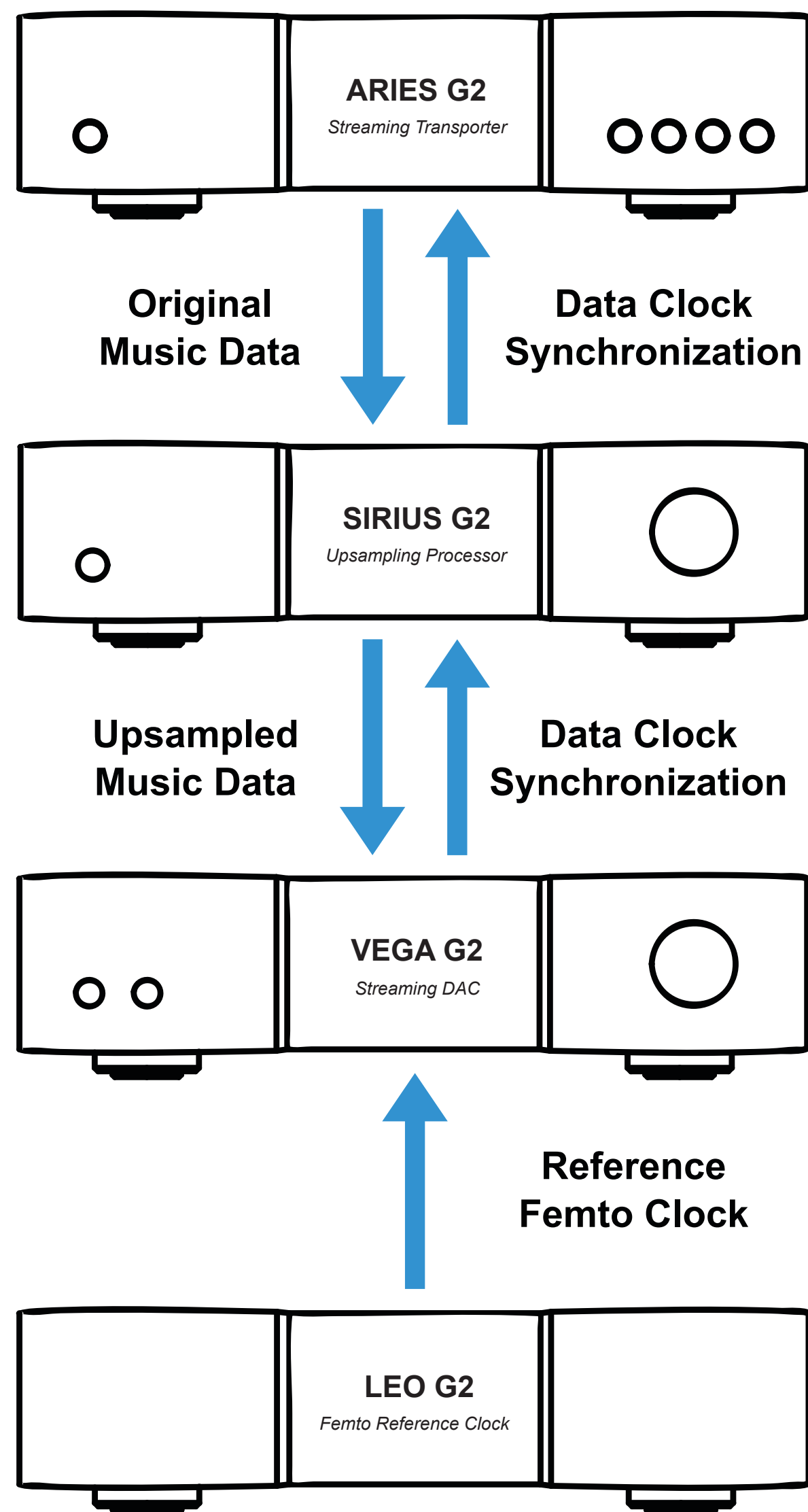

- DAC is the source of clock to driver other devices in the system.
- DAC use lock clock, no jitter from source or during transmission.
- 18Gbps bandwidth, very low jitter and timing error.
- True Jitter-Free Operation.

ARIES G2 New Features

- Tesla G2 Platform
- Lightning Link
- Dual Femto Clocks
- Dual Linear Purer-Power Supply
- Dual Galvanic Isolations
- Unity Chassis
- Smart-IR Remote Control
- Optional Internal Storage

Isolations of ARIES G2

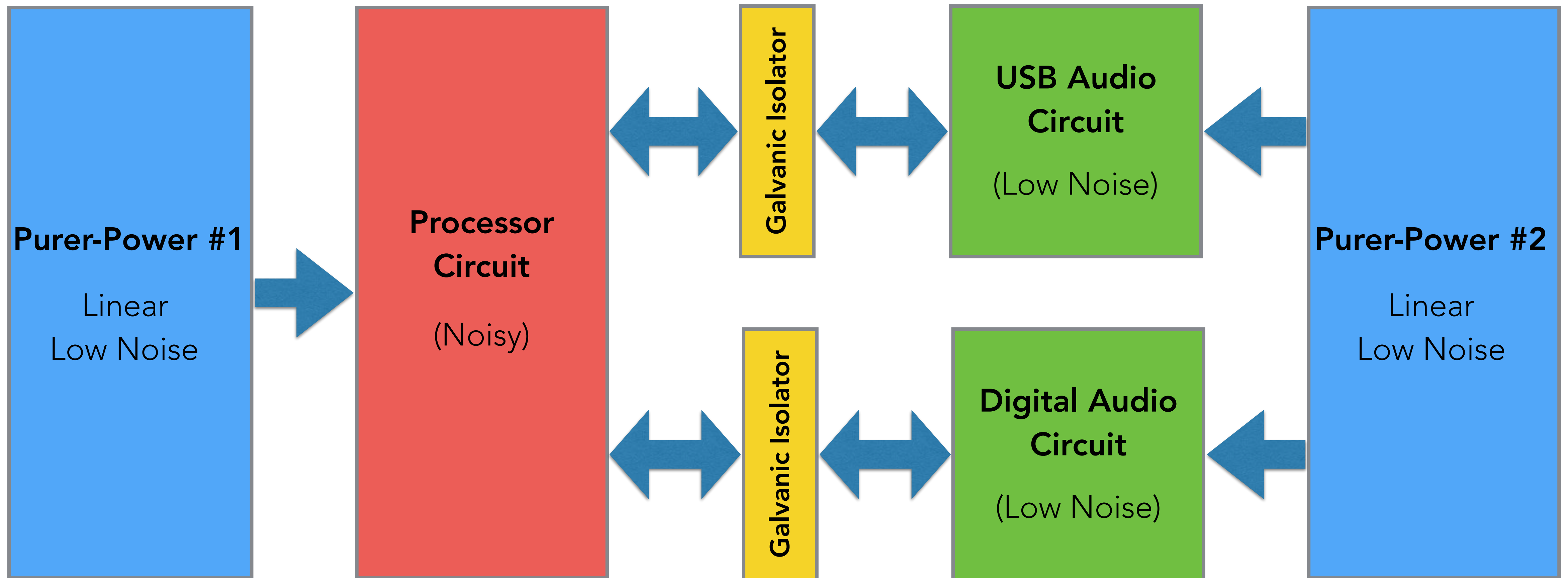

Inside ARIES G2

- Dual Transformer
- Dual Linear Purer-Power
- Galvanic Isolation
- Optional Internal Storage

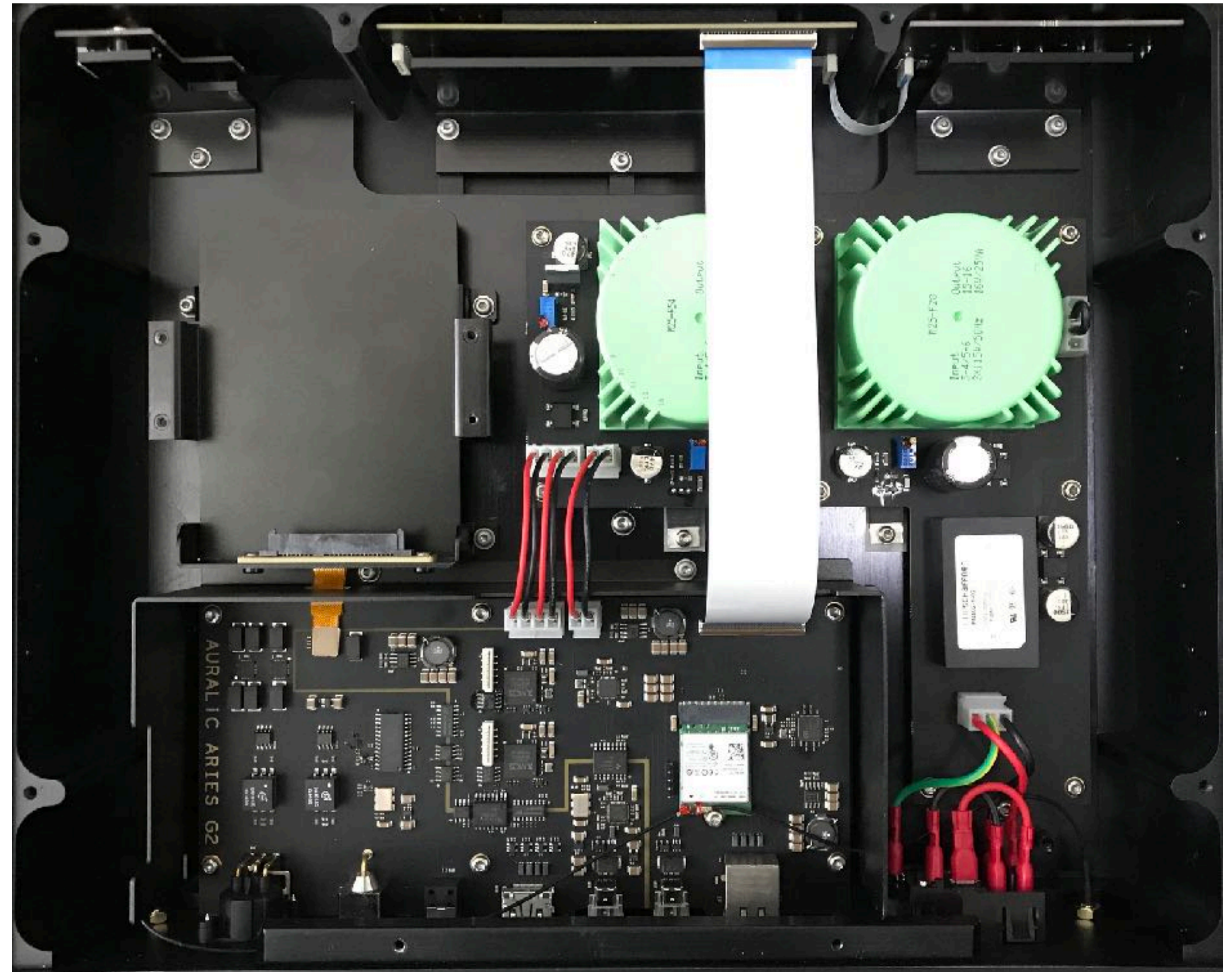

Smart-IR Remote Control

Too much remote control?



You don't need another one from AURALiC!

	ARIES	ARIES G2
Processor Frequency	25,000MIPS	37,500MIPS (50% faster)
System Memory	1GB	2GB
Data Storage	4GB	8GB
Format Support	Up to DSD256	Up to DSD512
Lightning Link	/	Yes
Galvanic Isolation	/	Yes
Purer-Power	via External PSU	Built-in, Dual Channel
Optional Internal Storage	/	Yes
Display	Single Color	True Color
Smart-IR Remote Control	/	Yes
EMI Noise Shielding	/	Yes
Weight Balance Optimization	/	Yes

VEGA G2



VEGA G2

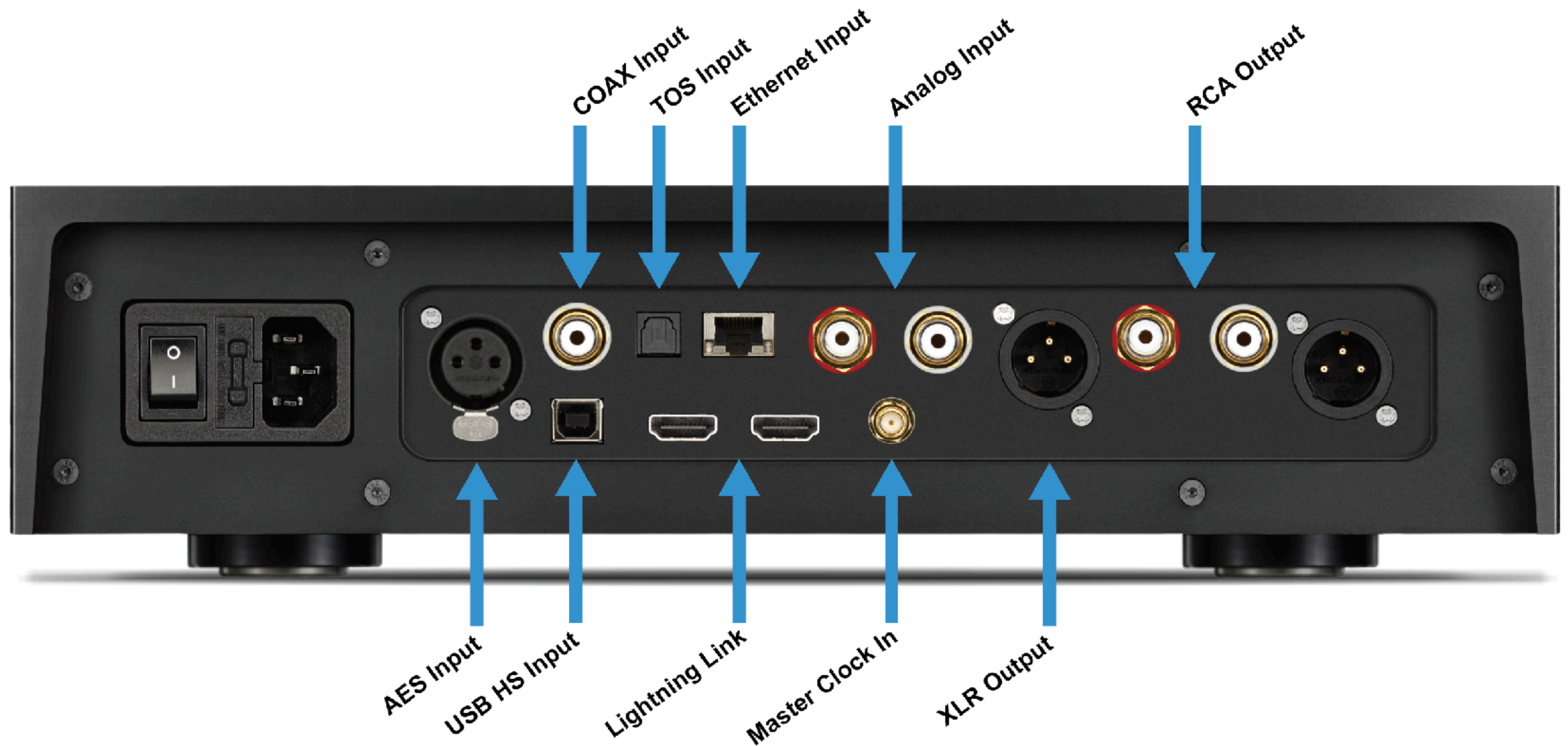

VEGA G2 New Features

- Lightning Streaming
- Dual 72 Femto Clocks
- Jitter-Free Operation
- AURALiC Tesla Platform
- Digital Audio Galvanic Isolation
- Full Passive Volume Control
- ORFEO Class-A Output Module
- Dual Low Noise Linear Purer-Power
- Unity Chassis
- 2nd Generation Flexible Filter Mode

Jitter-Free Operation

- DAC is the clock master and feed to all other circuits.
- No PLL, no lock to input signal, input signal jitter is not important.
- Galvanic Isolator to eliminate digital input noise.
- Sound quality not affected by input completely if no data error.

VEGA G2 Signal Flowchart

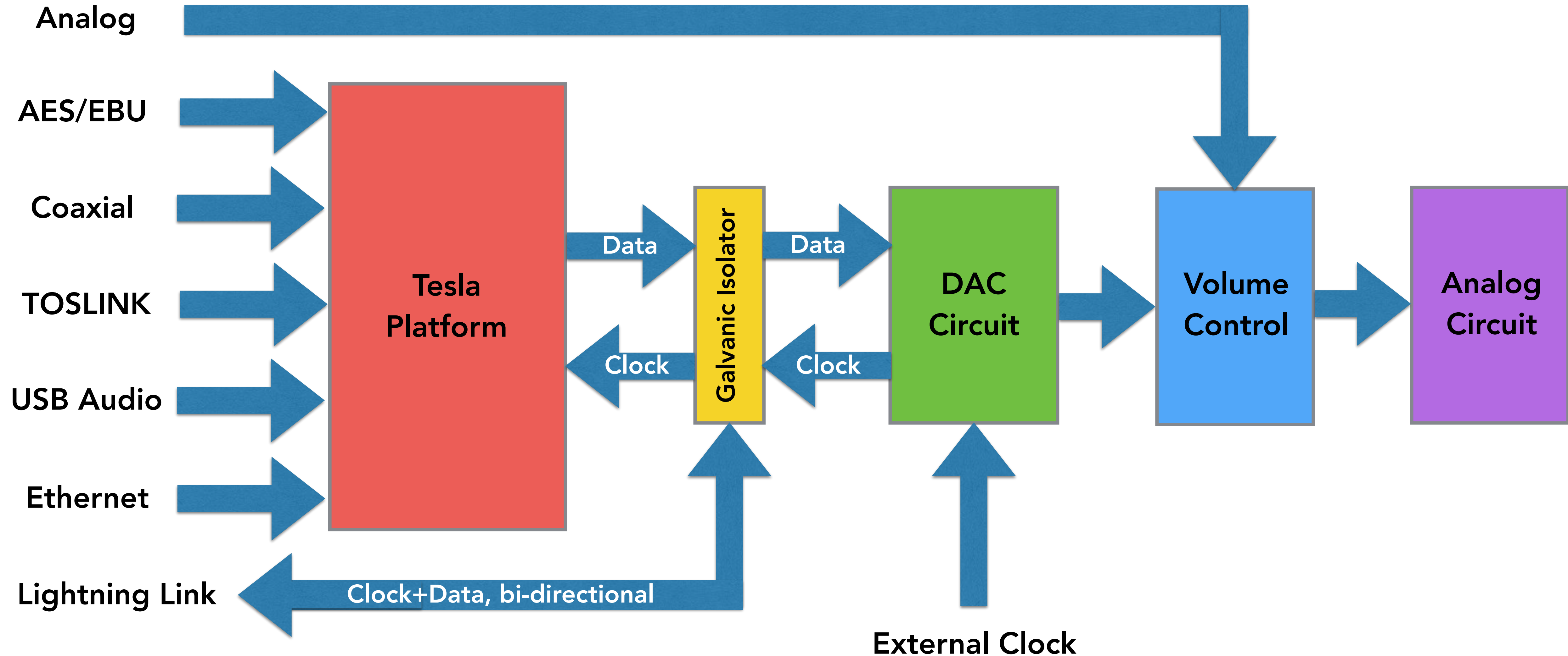

Challenge of Volume Control

- **Digital Control** - OK but not good for low volume
- **Analog Control**: Best approach but can be expensive to do it right
- **Hybrid Control** (AURALiC Polaris): Cost effective, good at low volume

Fully Passive Volume Control

- Full analog volume control, digitally controlled from 0dB to -128dB with 0.5dB step.
- R-2R resistor ladder attenuator network, extremely low noise.
- Control by eight coil-latch type of relays.
- The coil-latch relay is like e-reader display, it only consumes power when switch its status.
- Using coil-latch type of relay means zero power consumption, avoid EMI noise generated by relay coil.

	VEGA	VEGA G2
Streaming Inputs	/	Yes
Lightning Link	/	Yes
Format Support	Up to DSD256	Up to DSD512
Processing Speed	1,000MIPS	25,000MIPS
Femto Clock	Single 82 Femto-second	Dual 72 Femto-second
Operation Mode	Slave (DPLL)	Master (Jitter-Free Operation)
Flexible Filter Mode	1st Generation	2nd Generation
Galvanic Isolation	/	Yes
Volume Control	Digital	Full Analog & Passive
Analog Input	/	Yes (No gain, full analog)
Linear Power Supply	Single	Dual
Display	Single Color	True Color
Smart-IR Remote Control	/	Yes
EMI Noise Shielding	/	Yes
Weight Balance Optimization	/	Yes
Firmware User Upgradable	/	Yes

SIRIUS G2



Very high quality DSD upsampling

Other signal processing and reclocking

Lightning Link for G2 product or standalone

LEO G2



Extremely Low Jitter Mater Clock

Extremely Low close-in Phase Noise

Boost sound quality of VEGA G2

Availability

- **ARIES G2** - September 2017 - \$3899/€4199/£3899
- **SIRIUS G2** - End of 2017 - Price TBD
- **VEGA G2** - September 2017 - \$5699/€6299/£5499
- **LEO G2** - End of 2017 - Price TBD

Thank You!